

Manganese Dioxide Lithium Button Cell(Li/MnO₂)

MODEL: CR2430

Nominal capacity (0.4mA to 2.0V)	270 mAh
Nominal voltage	3.0 V
Max. Continuous operating current	6 mA
Max. Pulse current	21 mA
Battery weight	4.0 g
Battery dimension	φ 24.5×3.0 mm
operating temperature	-30°C~+60°C

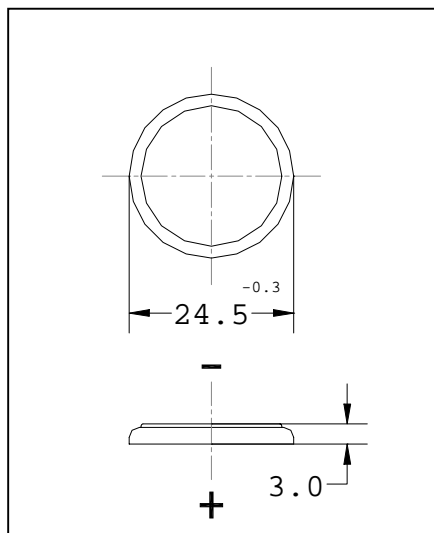

Electrical Characteristics:

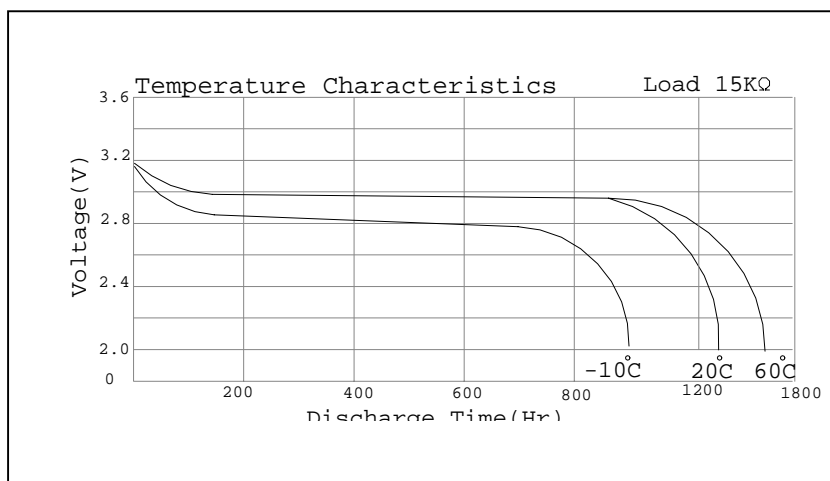
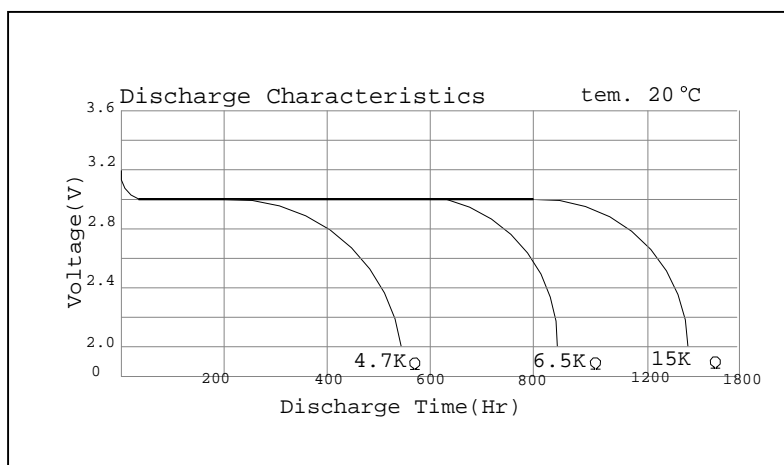

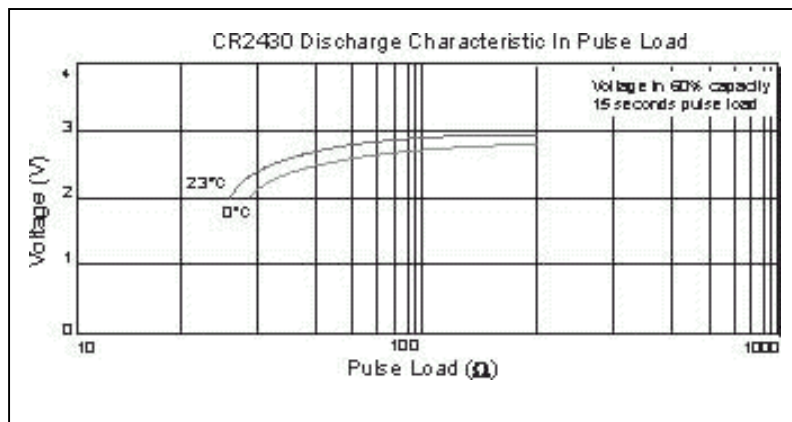
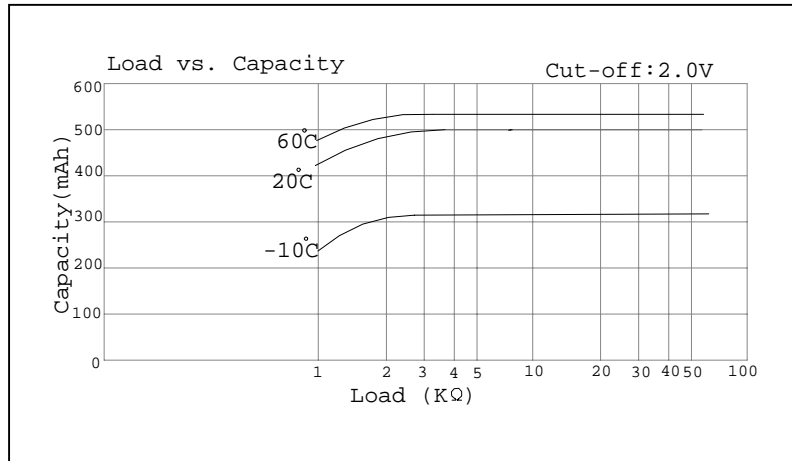

Warning:

- .Do not short-circuit;
- .Do not recharge, force over-discharge, assemble / disassemble and crush; risk of fire and burns;
- .Do not use under temperature above specified range