

Manganese Dioxide Lithium Button Cell(Li/MnO₂)

MODEL: CR1220

Nominal capacity (0.05mA to 2.0V)	35 mAh
Nominal voltage	3.0 V
Max. Continuous operating current	2 mA
Max. Pulse current	5 mA
Battery weight	0.8 g
Battery dimension	φ 12.5×2.0 mm
operating temperature	-30°C~+60°C

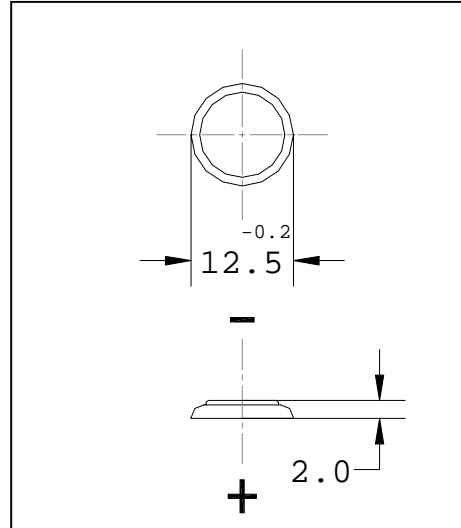

Electrical Characteristics:

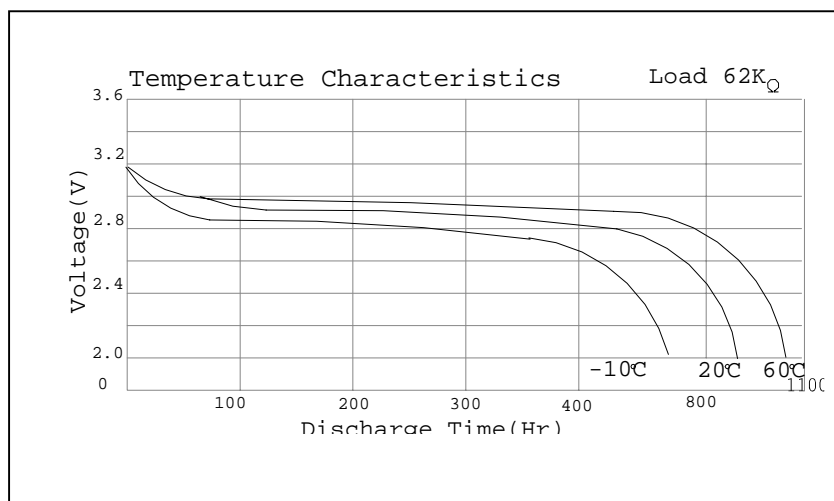
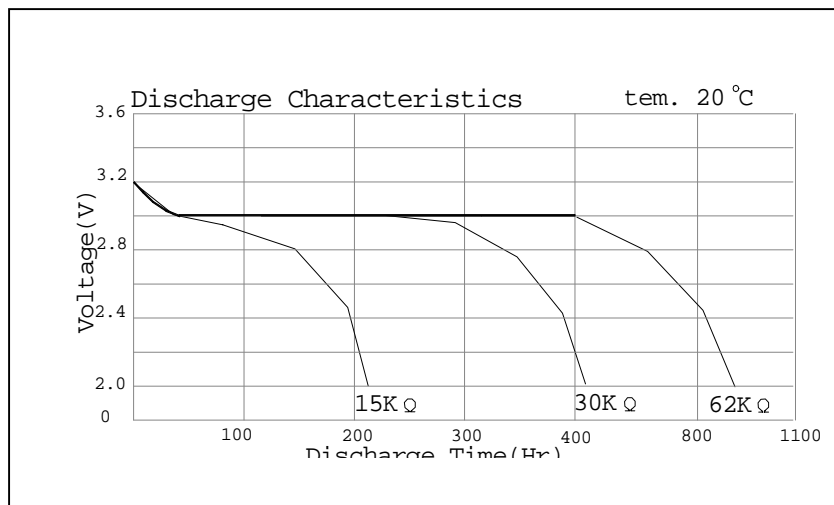

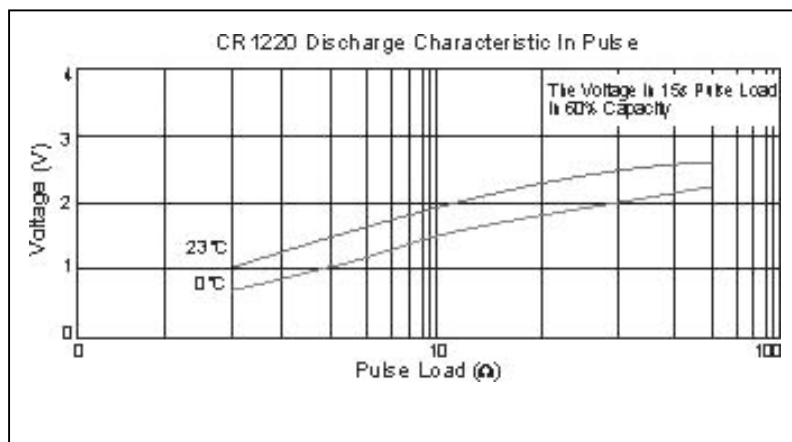
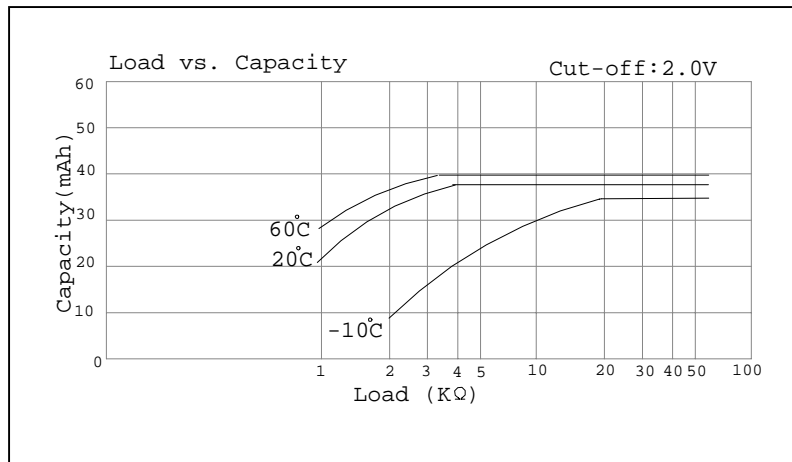

Warning:

- .Do not short-circuit;
- .Do not recharge, force over-discharge, assemble / disassemble and crush; risk of fire and burns;
- .Do not use under temperature above specified range